

Article number: 203180M24200C3T  
 Description: E+G levelling foot  
 GN 31-80-M24-200-C3-T  
 Note: T Without nut, Wrench flat at the bottom

## Measures

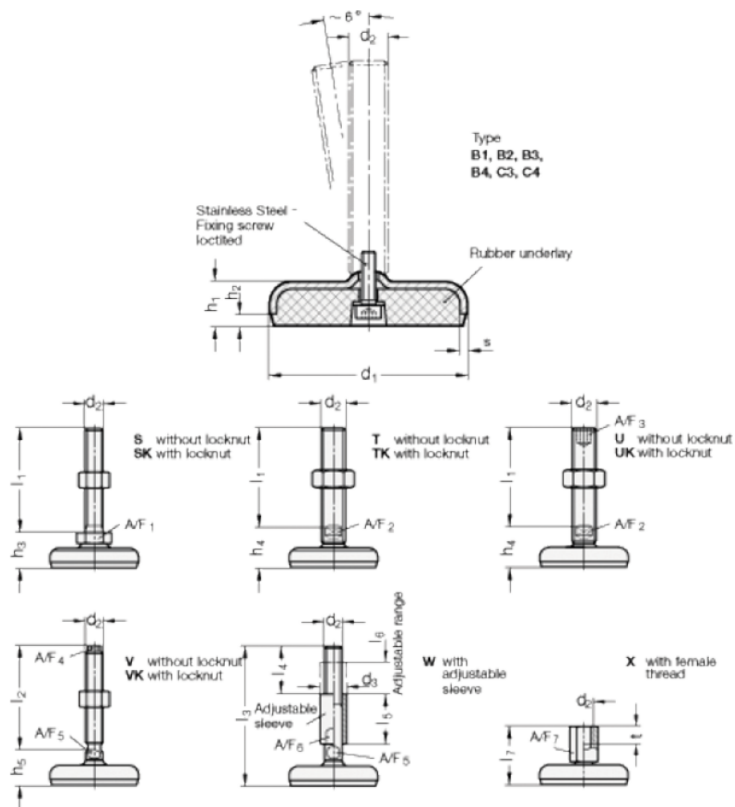

A/F2	= 19
d1	= 80
d2	= 24
h1	= 18
h2	= 5
h4 +4.0/0	= 36
l2	= 200
s	= 3